

**EVERPURE**

▶ FROM PENTAIR WATER SOLUTIONS

# 爱惠浦牌反渗透净水机

用户手册

使用本产品前，  
请仔细阅读本手册并妥善保管。



- 
- 
-

---

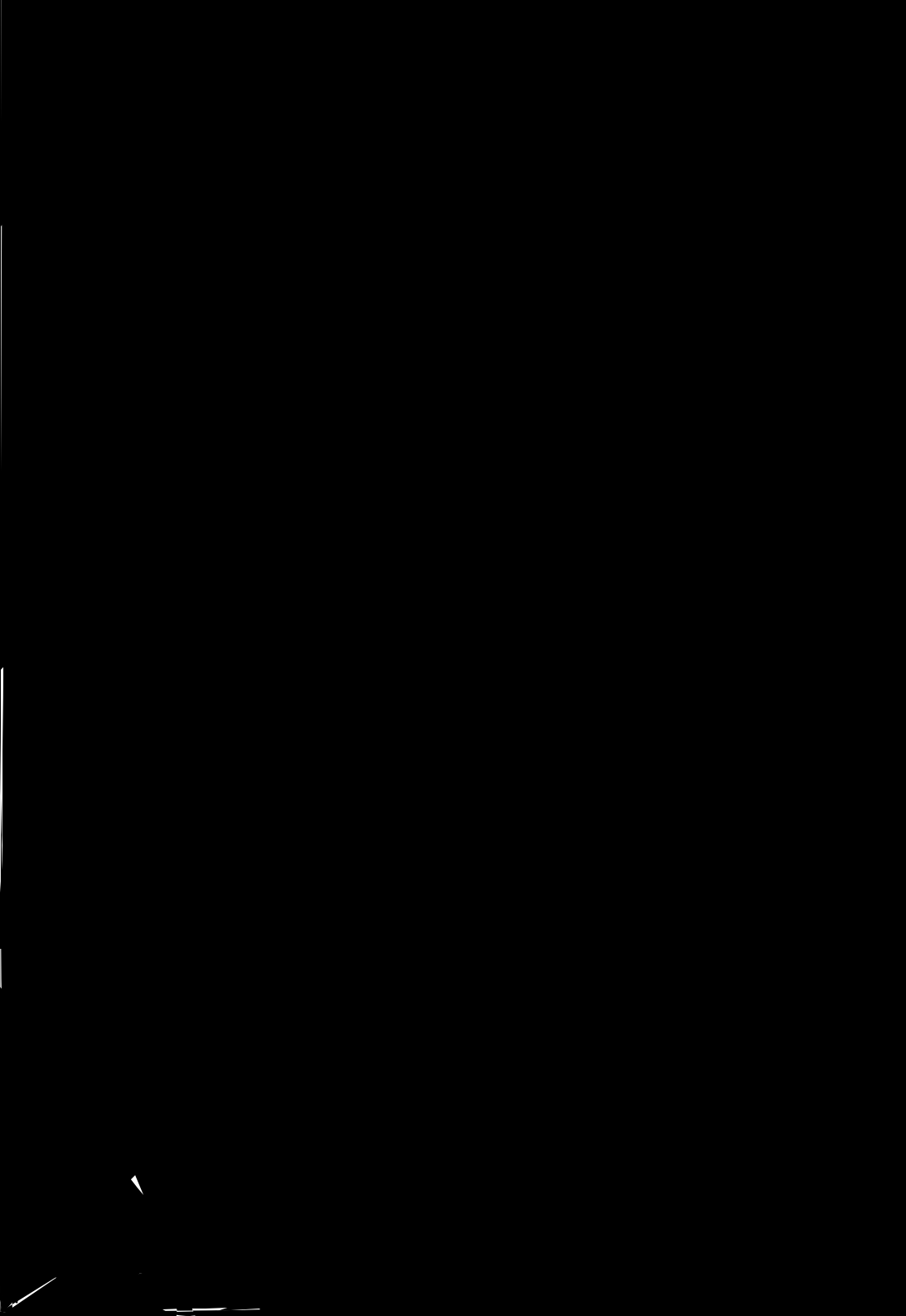
---

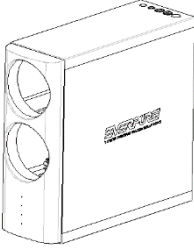
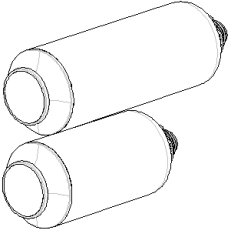

---

---



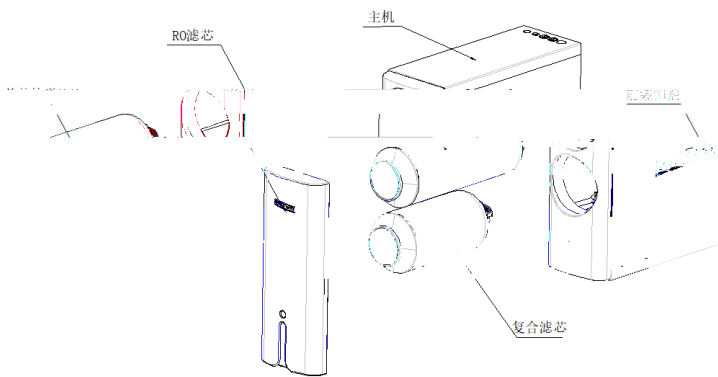

图一

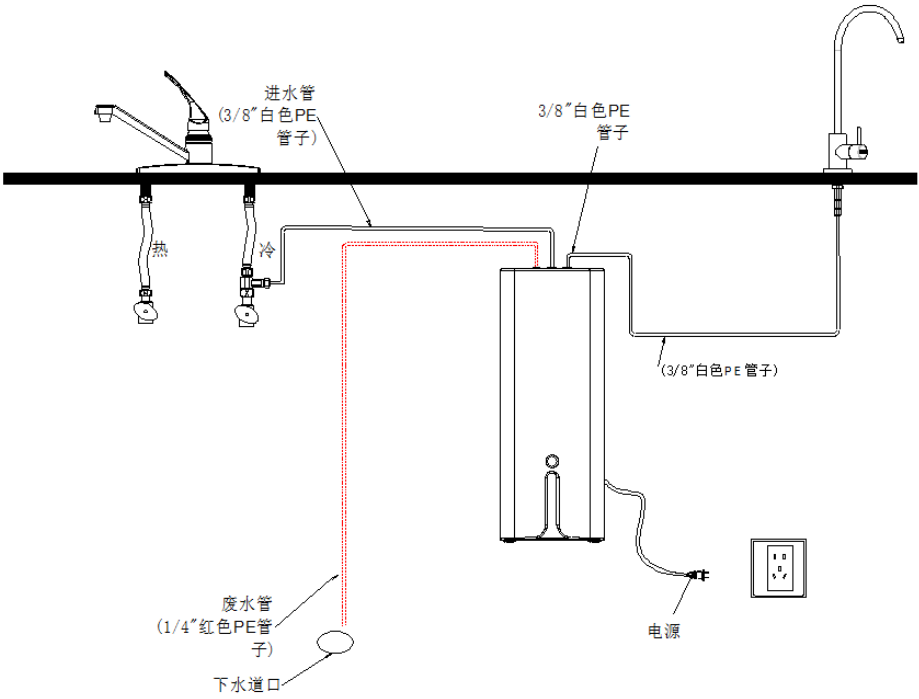

后  
机器安装

对应的安装孔位





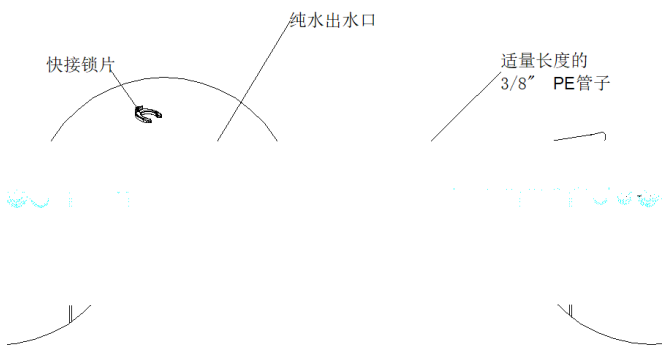







## 七、滤芯替换

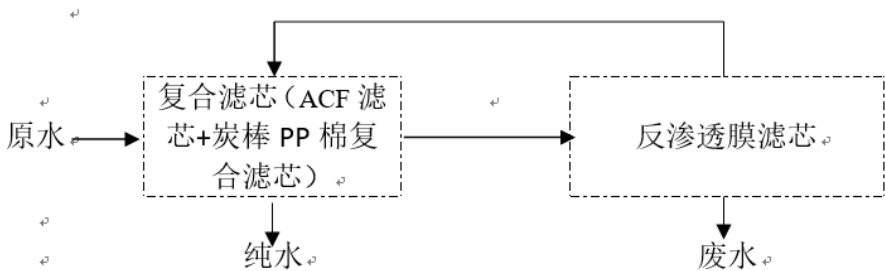

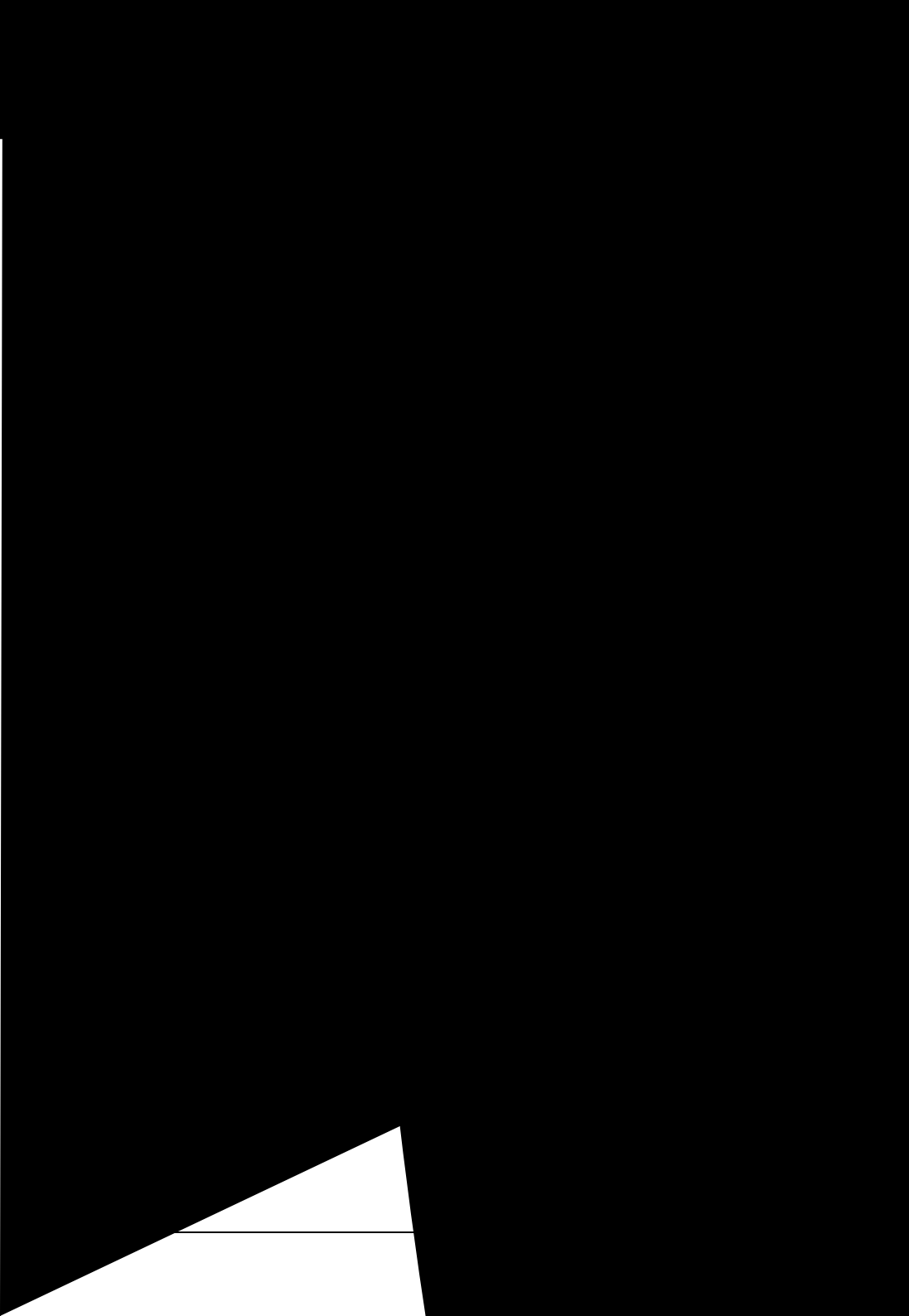

## 十一、净水器去除率/





---

-

- 
- 
- 
- 
- 
- 

---



